



The Art of Japanese Candlestick Charting

By

OPTIONSUNIVERSITY

Want to see more pro tips even better than Candlesticks? Click the button below to learn more.



Index

The Art of Japanese Candlestick Charting	1
Foreword.....	4
Candlestick Charting History	6
Significance of Candlestick Charting: Why is it Popular Among Traders?.....	9
The Philosophy of Candle Pattern Identification	12
Candlestick Charting: An Introduction	15
Long Days	17
Short Days.....	17
Marubozu	18
Spinning Tops	18
Doji	19
Candlestick Charting – Types.....	20
Candlestick Positioning	21
Long Black Line – Long White Line	21
Doji	21
Star Position	21
Harami Position.....	22
Reversal Signals	22
Dark Cloud Pattern	22
Piercing Line	23
Engulfing patterns.....	23
Stars	23
Morning Star	23
Evening Star Pattern.....	24
Doji Star	24
Rising and Falling Three Methods.....	24
Construction of Candlesticks: Reading the Chart	25
Detecting the 'Right' Candlestick Signals.....	27
Size	27
Shape.....	27
Location	27
Visual Insight.....	28
Reversals	29
Checking the Macro Environment	30
Pattern Analysis	32
Bullish Patterns	32
Bearish Patterns.....	40
Reliability of Pattern Recognition.....	48
BULLISH TRENDS.....	49
BEARISH TRENDS	51
Breakaway	51

Using Candlestick Patterns in Stock Analysis	53
Stocks That Work Best With Candlesticks.....	53
Candles Light the Way: Corporate Illustrations.....	54
Daily Chart WAL –MART Stores (WMT)	55
Daily Chart Cintas Corp (CTAS)	57
Interpreting Candlestick Patterns	59
Bullish Patterns	59
Bearish Patterns.....	63
Engulfing Bearish	63
Doji.....	66
Tweezers Patterns.....	68
Extended pattern groups	69
Techniques: Simple Steps for Better Returns	71
What Candlesticks don't reveal	74
Concluding Remarks	76
FAQ	78
What is the origin of candlestick charting technique?.....	78
What makes a candle?.....	78
Why should a trader use candlestick charting instead of western charting methods? ...	78
What are candlestick reversal patterns?.....	79
How effective are the signals?.....	79
Recommended Reading.....	80
Candlestick Terminology.....	81

Foreword

There is a Japanese saying “consult the market about the market” which means that when observing the market, we should pay close attention to the market movement itself, rather than observing the international affairs and economic policies that may or may not affect the market.

More than 200 years ago, the Japanese were using a unique style of technical analysis in the rice market that evolved into the candlestick technique currently used in Japan and elsewhere. The candlestick chart is a recording of market price movements in picture form. By studying the chart, one is able to identify the path a stock or commodity has taken in the past, and to predict the future course of the same. Investors are able to anticipate the realities of the future by sorting through the various candlestick shapes and patterns that have formed, and using only those with the highest probabilities. This is the basis of the candlestick charting technique. The chart's value is not in predicting exact tops or bottoms, but in instantly assisting to confirm market tops or bottoms when they form, and providing insight into market psychology.

Candlestick charts are a useful stand alone tool, but they can also be merged with other tools and techniques to create a powerful technical analysis system. Certain candlestick combinations may imply a period of consolidation; others hint at a forceful price move. Overall, they provide deep insight into market conditions.

Candlestick analysis has been used successfully in Japan for hundreds of years, and was never a hidden or secretive trading system. It has been only fairly recently that it first made its way into the U.S. trading community. Until then, there just wasn't any significant interest in investigating the candlestick technique from Western cultures. Even so, its potential was not broadly recognized as the prevailing perception has been that it was difficult to learn and very time consuming to employ effectively.

Now that the bull market of the late nineties has faded into memory, and current market conditions offer many challenges even to investors and traders seeking modest returns, interest in candlestick charting has been increasing dramatically. Investors new and old are now

seriously investigating methods that both protect them from severe losses and help identify substantial opportunities. Candlesticks can be used to further the investor's understanding of dozens of frequently reoccurring market scenarios. Combining candlestick charting techniques with traditional technical approaches creates a powerful formula for the savvy investor seeking to navigate these uncertain financial times.

Before we get into the candlestick charting techniques themselves, let's take a brief look at the history surrounding their use and development. In doing so, the reader will have a deeper appreciation and understanding of this unique and rewarding form of technical analysis.

Candlestick Charting History

Candlesticks have a rich history that extends far beyond their relatively short period of popularity among today's traders. The Japanese are credited for developing the candlestick techniques still in use today. These techniques originated in the technical charting methods used as far back as the 1600's. Over 100 years before the West developed the bar, point and figure analysis systems, Japanese candlestick chartists were drawing their charts on a scroll of rice paper, from right to left, with a crow quill and India ink ground by hand. Just spend a bit of time analyzing traditional candlestick formations and you will begin to see how, to this day, the patterns spell out market forces and investor psychology.

During the 16th and 17th centuries, the Japanese feudal lords waged constant wars; this was known as Sengoku Jidai, or "Age of Country at War." It was during this highly militaristic period that candlestick charting was developed. Naturally, the jargon of candlestick charting reflects this with numerous military terms and references. This turmoil gradually came to an end in the early 1600's as Japan was unified under the leadership of Nobunaga Oda, Hideyoshi Toyotomi and Leyasu Tokugawa. The collective achievements of these powerful feudal rulers known as "daimyo" are summarized in the saying, "Nobunaga piled the rice, Hideyoshi kneaded the dough, and Tokugawa ate the cake."

Osaka became Japan's capital during Toyotomi's reign. As a sea port, it was an ideal commerce center; land travel was slow and often dangerous, and therefore the port quickly emerged as a major trade hub. In warehousing and distributing commodities by sea and land, Osaka evolved into Japan's largest financial center. In time, Osaka's financial influence stabilized regional imbalances in rice prices. It was in Osaka at this time that Yodoya Keian became an immensely successful rice trader due to his ability to transport, distribute and set the price of rice. He was so successful that his front yard became Japan's first rice exchange.

During Yodoya Keian's ascendancy as one of the most powerful traders in Japan, society was divided into four classes: the soldier, the farmer, the artisan, and the merchant. The four

classes were ruled by a military government known as the bakufu, or shogunate. Sadly, the bakufu grew fearful of Keian's power and influence. They charged him with living a life of luxury beyond his social rank of merchant, and forced him to part with his fortune. With Keian out of the way, several competing rice merchants attempted to corner the rice market. However, the bakufu also confiscated these merchants' wealth and went even further - sending them into exile after executing their children.

As stability settled over the Japanese culture during the early 17th century, new opportunities also became apparent. The centralized government, led by Tokugawa, diminished the feudal system and paved the way for the expansion of the local markets to a centralized national market. The demise of local markets spurred the growth of technical analysis in Japan. Accompanying all these changes was the formation of the Dojima Rice Exchange -- the institutionalized market that began in Yodoya's front yard. Merchants were now capable of grading the rice, and negotiating the market price on a broad scale. The resulting economic expansion increased the use of candlestick charting as a tool for tracking the valuation of rice.

It has been rumored that candlestick charts were first introduced near the beginning of the Meiji era (around 1870) by an Englishman and were used primarily for the silver market in Yokohama. However, the most widely accepted theory as to how candlesticks were introduced into Japanese culture is that the chart originated with the beginning of the rice market (around 1750) as has been discussed above. Although it is still unclear as to precisely who is responsible for inventing the candlestick chart, there is no debate that much of the development and maturing process was thanks to Munehisa Honma. Although he was the youngest son at a time when tradition favored succession by the eldest son, he inherited his family's business on the merit of his extraordinary trading skill. Using candlestick charts, he was able to predict price moves to the degree that he conducted his trades directly from his home which was a previously unheard of practice. He managed this by paying men to convey his selling or buying instructions by waving a series of flags from the tops of buildings from Sakata to Osaka.

Honma's achievements were due in part to the fact that he applied candlestick charting in an innovative, new way. He researched the historic movement of rice prices in the context of seasonal weather conditions. His research established interpretations that he applied with great

success. He discovered that although there was a link between price and the supply and demand of rice, the markets were strongly influenced by the emotions of the traders. He understood that when emotions played into the equation, a vast difference between the value and the price of rice occurred. His findings are known as the "Sakata Rules", named after the Honma family's hometown. These principles are the basis for the candlestick chart analysis which is used to measure market emotions towards a stock. This difference between the value and the price is as applicable to stocks today as it was to rice in Japan centuries ago.

Due to the debasing of coinage, rice became the primary medium of exchange. Actual rice trading expanded into forming and negotiating rice warehouse receipts after 1710. They became known as rice coupons, and were the first forms of futures. The Osaka rice brokerage became the foundation for the city's wealth with 1,300 rice dealers occupying the Exchange. A daimyo in need of money could send his surplus rice to Osaka and get a receipt from a warehouse and this receipt could then be sold. Many daimyo found that cash flow problems could be eliminated through this method. Sometimes many future years of crops were mortgaged to take care of current expenses.

With the rice coupon becoming an actively traded entity, the Dojima Rice Exchange became the world's first futures exchange. Rice coupons were also called "empty rice" coupons, rice that was not in physical possession. Rice futures trading became so established in the Japanese marketplace, that in 1749, 110,000 bales were freely traded while there were only 30,000 bales in existence throughout Japan. It was during this time period that trading based on candlestick charts became more refined.

Following the commodity traders' success with candlesticks, the Japanese later integrated these techniques into their stock market. Still later, after World War II, the chart became very popular in Japan due to an increase in the number of active speculative investors. Prior to the last 50 years or so, the candlestick technique was known to only a few Japanese investors. Now, however, Japan's most elusive technical trading methodology has entered the twenty-first century and traders world wide are interested in profiting from the wealth of knowledge that is only available with this technique.

Significance of Candlestick Charting: Why is it Popular Among Traders?

One reason that candlestick charting technique has become very popular among traders today is that it accurately reflects short-term outlooks -- sometimes lasting less than eight to ten trading sessions. Candlesticks blend perfectly with nearly all of the traders' common technical analysis methods, and will increase one's understanding of any commodity or stock issue as well as provide an incredible insight into the market's future price moves. While candlestick charting has historically been a sometimes challenging system to understand, our technologically advanced era provides the necessary tools (computers and software) to simplify its use, and makes it accessible to anyone motivated to learn it.

Investors find candlestick charts easy to understand and interpret, with even rookies taking advantage of these charts. Michael Feeny, economist at Sumitomo Bank, says, "Candlestick charts are immensely flexible and provide a powerful addition to more common chartist techniques, and an extra dimension to your breakdown of future trends."

Candlestick charting offers several advantages over other investment techniques. It helps investors enormously when they try to pin down the best trading stocks in the market. The indirect logic provided by the signals gives investors a platform to further analyze the market. This method always places the odds in favor of the investor. Candlesticks are known to help investors take advantage of human emotions; they can also use them to get rid of emotionally based weakness in their own portfolios.

Candlesticks are especially popular because they give investors a very clear visual image of a stock's progress. They provide deeper insight into the direction of the market as compared to other types of charts. Most investors feel that candlestick charts are more visually informative and appealing -- therefore it is easier to draw inferences from them. A candlestick provides an encapsulated picture of the stock movement so investors can easily compare the opening and closing prices, as well as the high and low. A major difference between candlestick charting and other investment techniques is that candlestick charting is the visual indication of what has

occurred, while other techniques usually depict a trend that may occur. This highly popular method intuitively reveals the investment trends in a particular stock.

The growth of interest in candlestick charts also owes a lot to the colorful terminology used to describe the patterns. Investors become addicted to this terminology, and find it very difficult to give it up with the result that they can't even dream of going back to simple bar charts. A commonly cited example is of "dark cloud cover". It is corresponding to bearish one-day reversal and indicates that the stock market is getting stormy and investors should be ready for it. The terminology includes other interesting names, such as Hanging Man, and Shooting Star.

Another important advantage of candlestick charting is the combination of patterns. The tools can be flexibly used with any of the Western technical analysis tools, such as moving averages and oscillators. A key advantage of candlestick charts is the signals, which are not available in bar charts. "Technical analysts are realizing that anything you can do with a bar chart in western terms, you can do with a candlestick," says Steve Nison, senior vice president at Daiwa Securities America Inc. and author of several books on Candlestick Charting.

These charts show changes in volatility and momentum without the use of oscillators -- if oscillators are used in addition to candlesticks, the analysis becomes truly robust. Candlestick charting has also highly improved the precise identification of reversal signals. Signals occur on a daily basis and eight to ten signals are sufficient for establishing a trend.

The correlation between the open and close is a piece of critical information for investors. White candlesticks indicate buying pressure while black candlesticks indicate selling pressure. Candlestick charts put immense emphasis on the psychological aspects of openings and closings, and other movements of the markets. The opening and closing indicate the trading mindset for the day. The opening provides the first hint to the direction of the market and the more anxious traders like to start trading earlier in the day.

Candlestick charting not only illustrates the trend, but also the forces underneath that trend. It helps investors protect their investments by enabling them to see indications that a new high or low may not continue long.

Now that the historical context and growing popularity of candlestick charts have been presented, and the reader has a better understanding of the strengths of this analysis method, it is important to look into the philosophy behind the charts.

The Philosophy of Candle Pattern Identification

What makes the Japanese candlestick different from the western technical analysis is that it takes into account human emotion, mass psychology and mood of the moment. Technical analysis is simply the study of prices as reflected on price charts. Technical analysis assumes that current prices represent all known information about the markets. But prices not only reflect intrinsic facts, they also represent a lot of other factors. Prices are a function of supply and demand, and both supply and demand are affected by emotions. Markets move based upon people's expectations, not necessarily facts. A person shouldn't attempt to disregard the emotional component of trading by making his decisions based upon chart formations, assuming that prices reflect both facts and emotion. There is also a difference between value and price, which needs to be taken into consideration while doing any kind of analysis based only on price.

In western technical analysis, standard bar charts are commonly used to convey price activity into an easily readable chart. It usually indicates the opening price, the highest price for the session, the lowest price for the session and the closing price. A price bar can represent any time frame from one minute to one month. The total vertical length/height of the bar represents the entire trading range for the period. The top of the bar represents the highest price of the period, and the bottom of the bar represents the lowest price of the period. The Open is represented by a small dash to the left of the bar, and the Close for the session is a small dash to the right of the bar.

Candlesticks use the same price data as bar charts, yet the candlestick technique is better equipped to recognize complex patterns and to identify what these patterns mean. A Japanese candlestick is different from the bar charts as it is concerned with the relationship between opening and closing prices. The bar charts place more emphasis on the progression of the closing price from the earlier day's close. Candlestick chartists are more interested in the relationship between the closing price and the opening price of the same trading day. One can see how much easier looking at the change in body color of the candlestick chart is for interpreting the day-to-day sentiment. The candlesticks are much more visually appealing, and convey the price information in a quicker, easier manner. On the Candlestick charts, there are

several patterns to look for which signify bullish and bearish conditions. Candlesticks are a true leading indicator. They regularly identify potential market price moves before they begin to happen.

Candlesticks can also be applied to any other Western technical oscillators to produce a synergistic trading approach. Candlesticks are the only technical analysis tool that generates intuitive text messages (results) about the inner psychology of any market.

The greatest advantage of a candlestick chart is its ability to read the market sentiments and predict the market. Let's compare the western trend analysis and the candlestick chart using a market situation.

Suppose one buys a particular stock and at the end of the day finds that the stock closed well above the purchase price. The closing price of the second day is also higher than the previous day's closing price. When the closing price of the third day is slightly lower than the previous day's closing price, it doesn't affect one much. If at the end of the fourth day one finds that the stock has fallen significantly relative to the prior day's close, one is now concerned about protecting profits and at the beginning of the next day the trader sells off the stock at the first opportunity. The sell is executed at a price several points below where one had entered.

If we deal with the same stock using a candlestick chart, then we find that at the beginning of the first day one buys the stock based on a candlestick pattern entry signal. At the close of the day's trading we find that the stock closed well above the purchase price. After the close of the second day, one observes the candlestick formed for the day and finds that the real body is small which indicates that there was a tug of war between the bears and the bulls.

Now one observes that the real body is black in color, which indicates that the stock closed lower than it had opened -- the bulls actually lost the tug of war to the bears.

Based on these observations one can conclude that sentiment of the market regarding the stock is changing. One can decide to sell the position at the day's close, or at the market open on the next day to lock the profit. This shows how a candlestick chart trader has the advantage over the western chart trader in that he can use the signals generated by the candlestick to help

anticipate the changing sentiments of the market regarding the stock. Thus the open to close relationship as revealed in the candlestick chart is more effective than the close-to-close relationship commonly used by western traders.

In the next section, the reader will be introduced to the fundamental characteristics of the candlestick charts that will act as building blocks for the subsequent sections.

Candlestick Charting: An Introduction

Candlestick charting allows a quick read on changes in supply and demand. By analyzing the daily price movements of an issue using candlesticks, a trader is able to confirm evidence of trend reversal very early on. Candlesticks draw an inductive, as opposed to deductive, view of markets – the facts are presented graphically, one has only to read and understand.

The candlestick graph is comprised of both black and white candle bodies, often with "wicks" at both ends. A single white candlestick body highlights that the opening price was at the bottom of the body of the candlestick. In the case where the candle has wicks on either end, the bottom wick symbolizes the low prices traded during that period and the top wick points to the high of the period. Whenever a candle body is black, the opening price is the top of the candle body and the closing price is the bottom of the candle body. Again, if there are wicks, they signify intra-day highs and lows.

Candlestick charts are considered to be much more visually attractive than a standard two-dimensional bar chart. Similar to a standard bar chart, there are four elements needed to construct a candlestick chart, the Open, High, Low and Closing price for a given time period. Given below are the illustrations of candlesticks and a definition for each candlestick component.

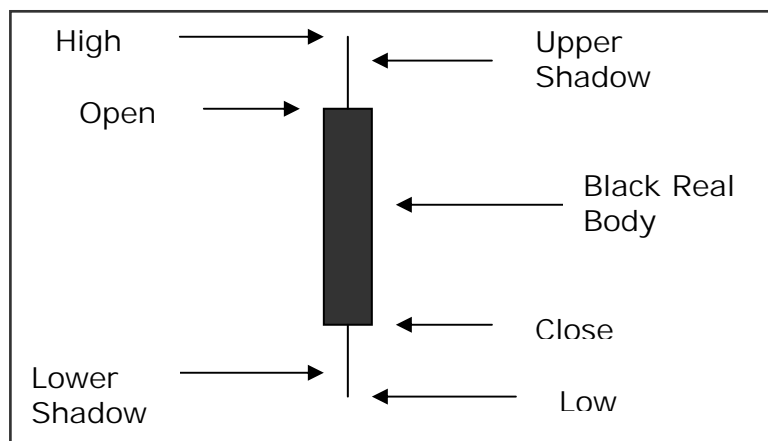
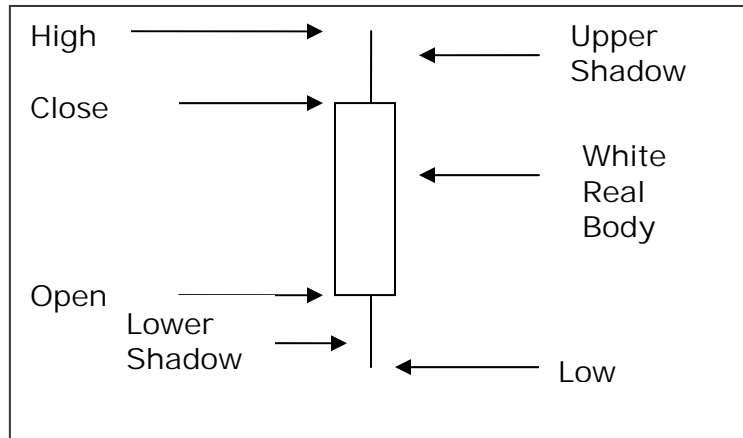

- The body of the candlestick chart is known as the real body, and represents the range between the open and closing prices.
- A black or filled-in body highlights that the close during that time period was lower than the open (usually considered bearish). When the body is open or white, it shows the close was higher than the open (usually considered bullish).
- The slim straight line above and/or below the real body is known as the upper/lower shadow, representing the high/low price limits for the period.

Below is a list of several individual candlestick terms. It is very important to realize that many formations occur within the context of prior candlesticks.

Long Days

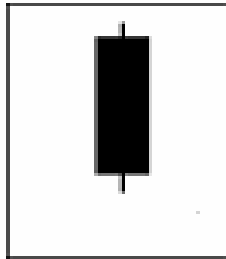

Long Black Day

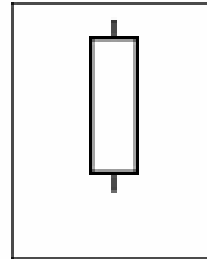

Long White Day

The Long Days point towards the huge difference between the open price and the close price for a trading day. The shadow lines are a lot shorter than the real body.

Short Days

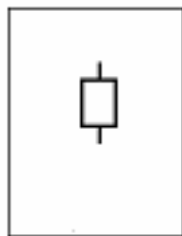

Short White Day

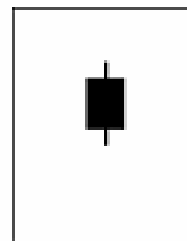

Short Black Day

The Short Days indicate little difference between the opening price and the closing price for a trading day. The body and the shadow lines are both very short.

Marubozu

Marubozu indicates that there are no shadows from the bodies

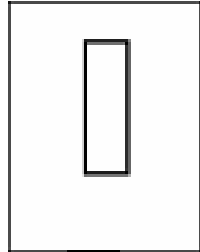

White Marubozu

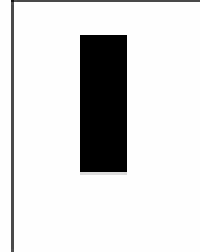

Black Marubozu

A White Marubozu is a long white body without any shadows and indicates a bullish trend. It generally becomes the first part of a bullish continuance or a bullish reversal pattern.

A Black Marubozu is a long black body without any shadows. It generally implies bearish continuation or bearish reversal.

Spinning Tops

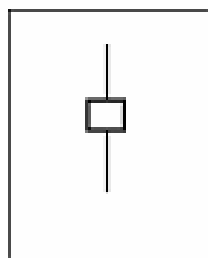

White Spinning Tops

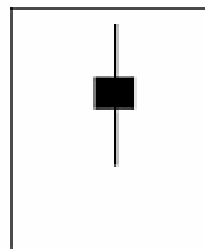

Black Spinning Tops

The Spinning Tops have much longer shadows than real bodies. The colors of the real bodies are not essential. The pattern points towards the indecisiveness between the bullish and bearish trends.

Doji

Doji lines are considered to be patterns with the same open and close price. There are four special types of doji lines.

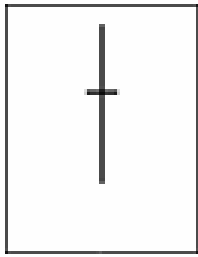

Long-legged Doji

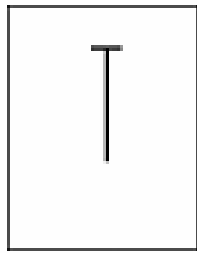

Dragonfly Doji

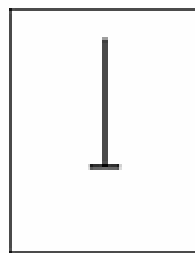

Gravestone Doji

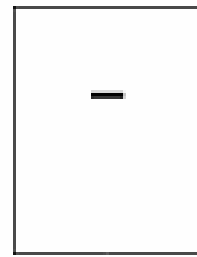

Four-Price Doji

Long-legged Doji: Comprised of long upper and lower shadows with the price in the middle of the range. It indicates indecision.

Dragonfly Doji: Comprised of a long lower shadow and no upper shadow. It is a fine indication of bearish trend reversal.

Gravestone Doji: Comprised of a long upper shadow and no lower shadow. It is a perfect indication of bullish trend reversal.

Four Price Doji: Open, high, low and close are all the same for a trading day. It's a very distinctive line that indicates the indecision of the traders, or a very quiet market.

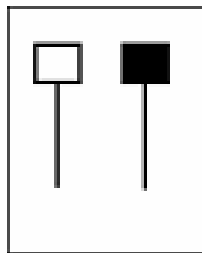

Paper Umbrella

The Paper Umbrella emerges when a small body comes with a long lower shadow. It is considered to be a strong reversal sign.

Candlestick Charting – Types

Candlesticks contain the same data as a normal bar chart, but in addition they highlight the relationship between opening and closing prices. It depicts the battle between Bulls (buyers) and Bears (sellers) over a given period of time. The narrow stick represents the range of prices traded during the period (high to low) while the broad mid-section represents the opening and closing prices for the period. The interpretation of candlestick charts is based primarily on patterns. The patterns are classified as Bullish, Bearish, trend reversal and neutral patterns. The bottom (intra-session low) of the candlestick represents a win for the Bears and the top (intra-session high) a win for the Bulls. The closer the close is to the high, the closer the Bulls are to winning the session. The closer the close is to the low, the closer the Bears are to winning..

A candlestick chart is a good representation of a stock's momentum. On a candlestick chart, one can easily see the succession of up days, down days and sudden changes in the stock pattern. The advantage of candlesticks is the ability to highlight trend weakness and reversal signals that may not be apparent on a normal bar chart.

Candlestick Positioning

Long Black Line – Long White Line

The long white line is a sign that buyers are firmly in control - a bullish symbol. A long black line shows that sellers are in control - definitely a bearish sign.

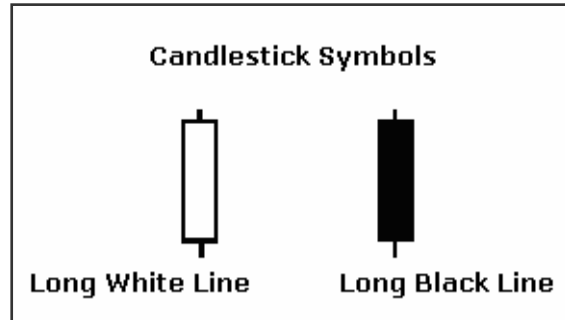

Doji

The doji occurs when the open and close occur at the same price. This signals indecision when open and close occur in the middle of the trading range. The dragonfly is a doji where the open and close occur near the top of the trading range. This signals a reversal after a downtrend; control has shifted from sellers to buyers.

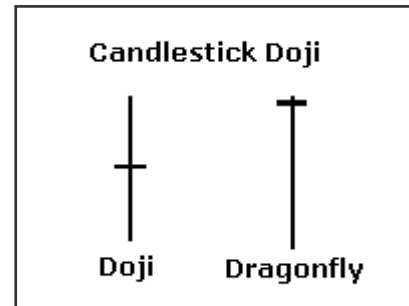

Star Position

A candlestick that gaps away from the previous candlestick is said to be in star position. The first candlestick usually has a large real body, but not always, and the second candlestick in star position has a small real body. Depending on the previous candlestick, the star position candlestick gaps up or down and appears isolated from previous price action. The two candlesticks can be any combination of white and black.

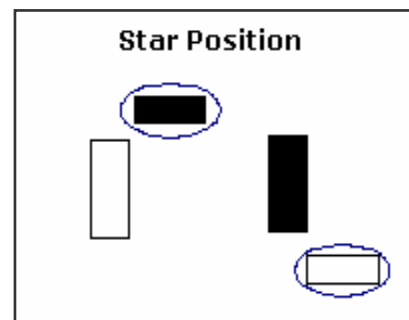

Doji, hammers, shooting stars and spinning tops have small real bodies and can form in the star position. Later we will examine 2- and 3-candlestick patterns that utilize the star position.

Harami Position

A candlestick that forms within the real body of the previous candlestick is in harami position. Harami means 'pregnant' in Japanese and the second candlestick is nestled inside the first. The first candlestick usually has a large real body and the second a smaller real body than the first. The shadows (high/low) of the second candlestick do not have to be contained within the first, though it's preferable if they are. Doji and spinning tops have small real bodies and can form in the harami position as well.

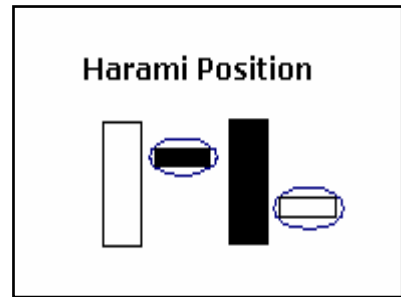

Reversal Signals

The hammer signals a reversal after a downtrend - control has shifted from sellers to buyers. The shadow should be at least twice the height of the body. If it occurs after an up trend, it is called a 'hanging man' and is a bearish signal. A gravestone is identified by open and close near the bottom of the trading range. This is really the converse of a hammer and signals a reversal when it occurs after an up-trend.

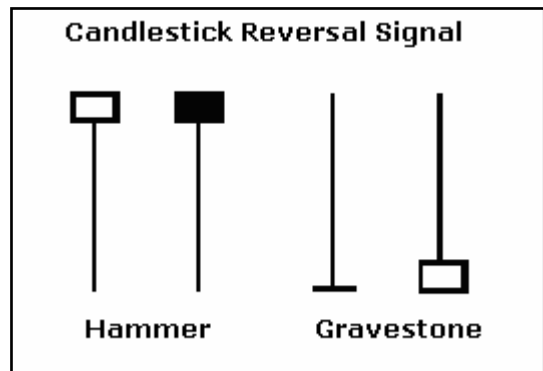

Dark Cloud Pattern

A Dark Cloud pattern encountered after an up-trend is a reversal signal warning of "rainy days" ahead.

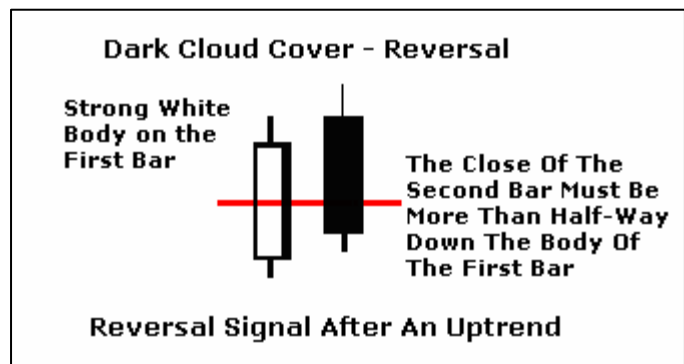

Piercing Line

The Piercing Line is the opposite of the Dark Cloud pattern and is a reversal signal if it appears after a downtrend.

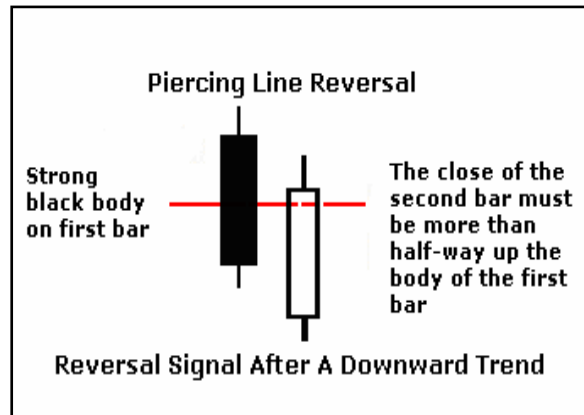

Engulfing patterns

Engulfing patterns consist of two bodies without any shadows and where the second body 'engulfs' the first. These signals are only significant after a prolonged trend.

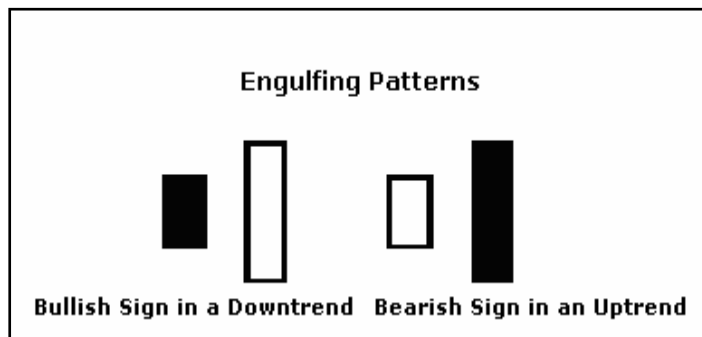

Stars

Stars are made up of a long body followed by a short body with a much smaller shadow (trading range). The bodies of the two must not overlap, though the shadows may.

Morning Star

The Morning Star pattern is a bullish reversal signal after a downtrend. The first bar has a long black body, the second body gaps down from the first (the shadows may still overlap) and may be filled or hollow. This is followed by a long white body, which closes in the top half of the body of the first bar.

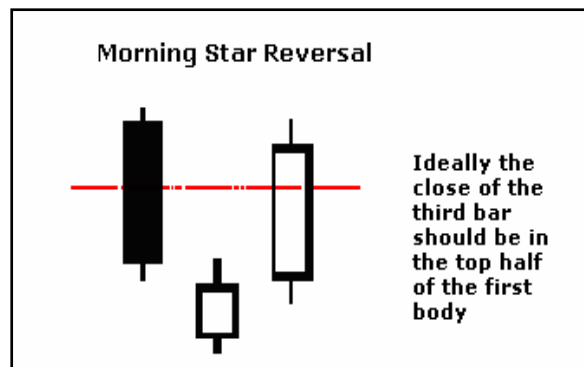

Evening Star Pattern

The Evening star pattern is opposite to Morning Star and is a reversal signal at the end of an up-trend. Evening stars is a three-candle pattern that comes after a rally. The first candle has a tall white real body, the second has a small real body that gaps higher to form a star, and the third is a black candle that closes well into the first session's white real body.

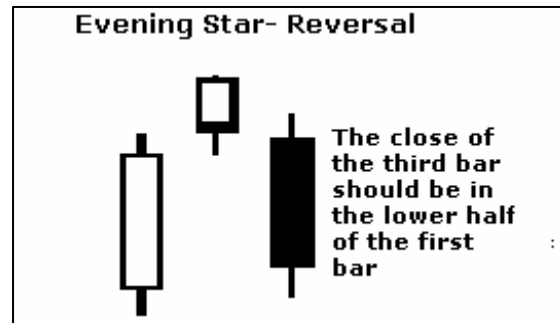

Doji Star

A Doji Star formation is weaker than the Morning or Evening Star - the doji represents indecision. With a Shooting Star the body on the second bar must be near the low - at the bottom end of the trading range. The upper shadow must be longer. This is also a weaker reversal signal after a trend. Both of these patterns require confirmation - by the next bar closing below halfway on the first bar.

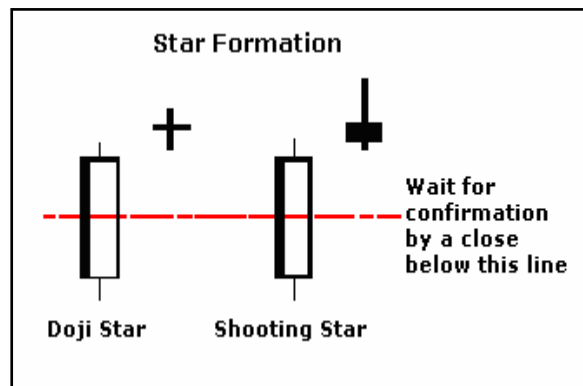

Rising and Falling Three Methods

The Rising Method consists of two strong white lines bracketing three or four small declining black lines. The final white line forms a new closing high. The pattern is definitely bullish. The bearish Falling Method is bracketed by strong black bars, the second black bar forming a new closing low.

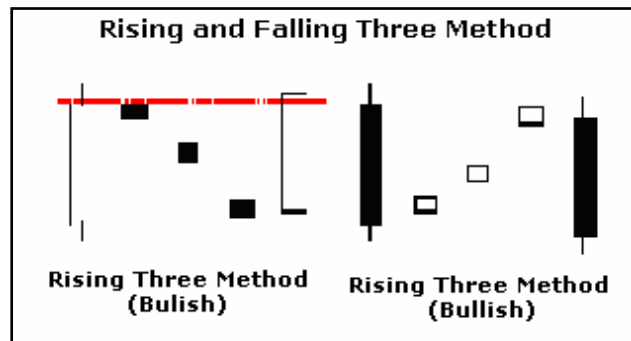

Construction of Candlesticks:

Reading the Chart

Like bar charts, Japanese candlestick charts use vertical lines to display price action for a particular period. Even to the casual user, a candlestick chart gives a clear indication of the intra-day price action. Please note that the following points are illustrated in the diagram on the next page.

Because of the emphasis placed on the Open-Close range, candlesticks are drawn with a "rectangle" around the Open-Close range. If the close is higher than the open, then the rectangle is left "Empty" - which appears as a "White" candle. If the close is below the open, then the rectangle is drawn in, or "Filled" - which appears as a "Black" candle. And, if the Open and Close are "Very Close" or "Equal", a small rectangle (or horizontal line) is drawn - creating a "Doji" shaped candle.

A candlestick chart represents a sequence of prices plotted over a specific timeframe. In statistical terms, these charts are referred to as time series plots.

On the chart, the y-axis (vertical axis) represents the price scale and the x-axis (horizontal axis) represents the time scale. Prices are plotted from left to right across the x-axis with the most recent plot being the furthest right.

Like a bar chart, the daily candlestick line contains the open, high, low, and close for the market for a specific day. The broad part of the candlestick line in the exhibit is called the real body as has been mentioned previously also.

The thin lines above and below the real body are the shadows. These are the session's price extremes. The shadow above the real body is called the upper shadow and the peak of the upper shadow is the high of the session. The shadow under the real body is the lower shadow and the bottom of the lower shadow is the session's low.

Candle lines can depict information for all time frames: intraday, daily, weekly, monthly, quarterly or annual data. The less compressed the data is, the more detail is displayed. For example, a 60-minute candle line uses the open, high, low and close for the day. On a weekly chart the candle would be based on Monday's open, the high and low of the week and Friday's close.

One very apparent indicator is the color of the candlestick's real body and the length of the candle lines real body and shadow. It conveys an instant x-ray into who's winning the battle between the bulls and the bears. For instance, when the real body is black, this means that the stock closed below its opening price. This gives a reader an instant picture of a positive or a negative closing. Those who stare at charts for hours at a time can find candlesticks are not only easy on the eyes, but also that they convey strong visual signals sometimes missed on bar charts.

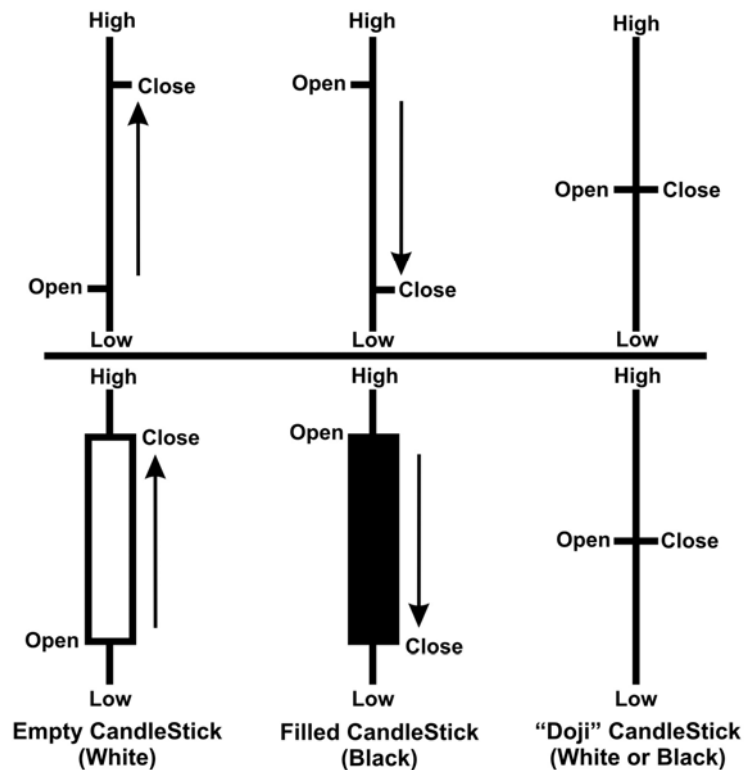

Detecting the 'Right' Candlestick Signals

As one learns to interpret the different candlestick patterns, one should always keep in mind the following rules to assist in detecting patterns and determining possible actions to be taken. There are three simple rules to interpreting candlestick patterns:

Size

Larger candles play an important role when identifying patterns. They represent accumulation or distribution within the market or stock. When you begin to see an increase in size of the candles, the trend is accelerating and accumulation is occurring. When you begin to see a decrease in the size of the candles, the trend is decelerating and distribution is occurring.

Shape

The shape of the candlestick, or pattern, determines the type of pattern generated, the possible trading signal, and the potential direction of trend. Shape and size work hand-in-hand. A very small Engulfing Bullish pattern would indicate the potential for a market rally, yet the small size indicates that the trend has not yet begun to accelerate.

Location

The location of a candlestick pattern will assist in determining the possible trading signal. For example, a Shooting Star found after a defined up trend strongly indicates a potential bearish correction or top. A Piercing Line found after a defined down trend indicates a potential for a bullish reversal. Either of these two patterns found within a consolidated sideways trend, do not indicate as strong a potential for a trend reversal, and one should wait for confirmation of the candlestick pattern before taking action.

Visual Insight

When a chartist looks at a bar graph, accumulations of highs and lows are often seen as key market levels. Breaking through these points signals important changes in the expected direction of prices. Candlestick real bodies, however, may turn out to be better for this task. Much like highs and lows are on bar charts, an accumulation of real-body highs or lows at a given level is significant.

Here's an example of real-body resistance levels. The real-body high from the first day provides the initial resistance point. Note how the second day's action takes prices above that resistance, but the market ends lower on the day. The situation is similar after the sixth day. Twice the market rallies above real-body resistance, only to

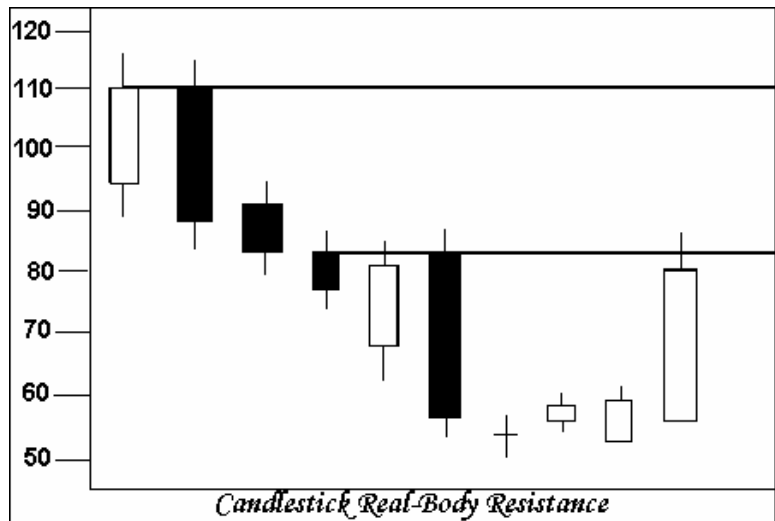

fall back. Real-body support levels work in a similar, but opposite manner. The last candlestick is what would be considered a breakout if it were able to close above the real body resistance of the fourth and sixth day. So in effect, there must be a real-body penetration of the support or resistance point before one considers the action to be significant.

Reversals

Candle charts reveal reversal signals earlier. Where on a bar chart it may take weeks, with a candle chart a reversal can be confirmed in one or two sessions.

For example, the following chart shows an evening star pattern formed on the NASDAQ composite chart. Using Western techniques, one could say that a head-and-shoulders top was forming. But it may take weeks for that formation to build and for the price to break through the neckline for bearish confirmation. Using the candlestick technique, the chart shows that the market formed the bearish candlestick pattern at the high of the "head." But the bearish confirmation from the break of the neckline took some time to occur [Break under Head and Shoulders].

Key Point – Candlestick charting patterns often give early price action signals when compared to western bar charts.

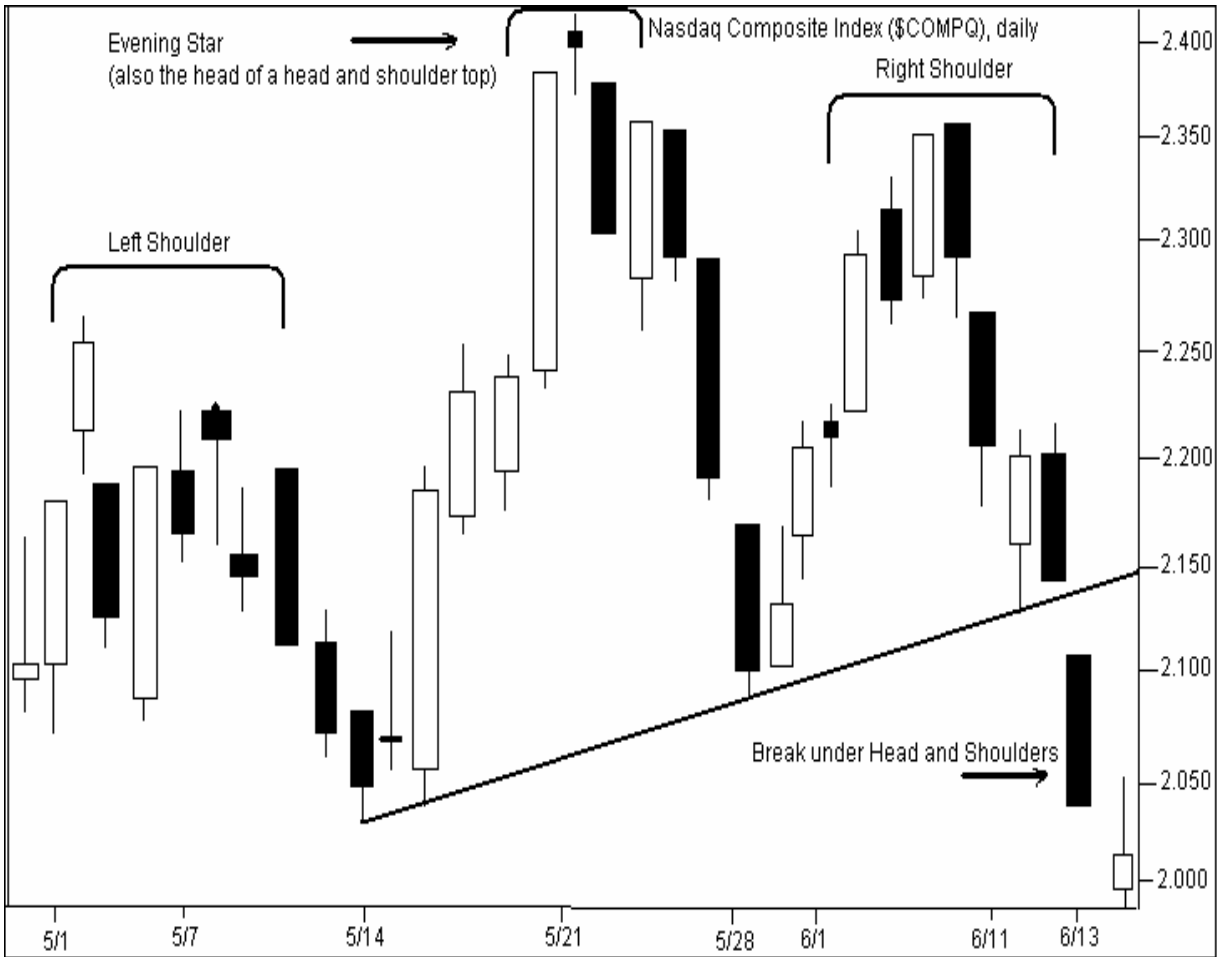

Checking the Macro Environment

For academics, checking the macro-environment involves study of supply and demand forces in the economy. For traders it is a method to forecast price movements of individual commodities and/or entire markets by looking at economic indicators and government policy within a business cycle framework. Analysis of the macro environment can explain or/and forecast market behavior, depending on the economic variables used. In a forecasting model, either past values are used to extrapolate future values, or knowledge of forces outside a particular commodity is used to forecast future prices (the explanatory variable must have high correlation).

Forecasts are only as strong as the data used to make them. Much fundamental data, no matter how accurate the estimates, are based on samples. In addition, the estimates are usually

subject to constant revision. Thus a forecast based on price data such as in candlestick charting, promises to have greater accuracy.

The candlestick chart graphically represents where the market opened and closed. The body represents that area of price range, between open and close where buying and selling support was forthcoming. If it was a black body one immediately recognizes that the bears won the battle that day and if a red body the bulls were in ascendance. The shadows tell of the failed attempts of bulls or bears to take the market their way. An upper shadow tells us the bulls attempted to take the market higher, by the length of the shadow, but their efforts failed to attract further buyers to join in the bull thrust, it only attracted sellers sufficient to accommodate the would-be buyers. On failing to drive the market higher the bulls retreated, beaten down by sellers. Conversely the lower shadow indicates the extent of the failure of the bears to take the market lower. As bears sold, bulls were ever present to buy up anything offered at these new lower prices. On recognizing the overwhelming preponderance of buyers the shorts retreated to the cover of the body.

One of the advantages of candlestick price patterns is that the underlying forces of the market for whatever period under study [month, week, day hour, or minute] are shown in an immediately recognizable graphic form. The market is telling investors and traders much of what they need to know, and candlesticks illustrate the story very well.

Pattern Analysis

A pattern can be formed by one or several candlesticks, but not more than five. Most of the time, candle patterns show reversal patterns but they also help in projecting trends. A reversal pattern shows that the direction of a stock is going to curtail its flow and at times this conveys that an uptrend or downtrend will reverse its course.

Bullish Patterns

A bullish pattern becomes evident when prices open near the low and close significantly higher near the period's high. Thirty-four bullish patterns are described as follows:

Abandoned Baby

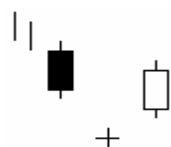

This is a three day pattern. The first day is a long black day followed by a doji that gaps in the direction of the previous trend. The third day is a white day gapping in the opposite direction with no overlapping shadows.

Belt Hold

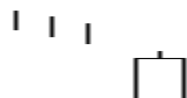

This one day pattern consists of a white day with no lower shadow and closes near the high of the day.

Breakaway

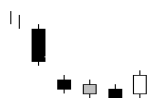

This is a five day pattern. A long black day is followed by another black day with gaps below the first day. The next two days continue in the same direction and close lower. The final day is a long white day that closes in the gap between the first and second days.

Concealing Baby Swallow



This is a four day pattern. The first two days are Black Marubozu days (open is the high of the day and the close is the low of the day). The third day is also a black day that gaps in the same direction but trades up into the body of the second black day. The final day is a Black Marubozu that gaps up and engulfs the third day.

Doji Star



This is a two day pattern. A long black day is followed by a doji, which gaps in the direction of the trend. The shadow of the doji is not long.

Dragonfly Doji



This one day pattern is a doji that forms at the upper end of the trading range with a long lower shadow. The longer the shadow the more the pattern is bullish.

Bullish Engulfing



This is a two day pattern. A large white day "engulfs" the previous black day that gaps below the black day's low and increases to close above its high.

Gravestone Doji

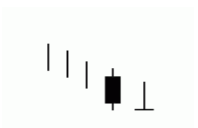

This is a one day pattern. A doji forms at the lower end of the trading range. The upper shadow of the doji is usually long while the lower shadow is small or may not exist at all.

Hammer

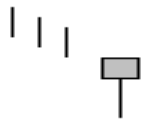

This is a one day pattern. A small body and a long lower shadow characterize the candle. The lower shadow should be at least twice the length of the body with almost no upper shadow.

Harami



This is a two day pattern. A white day follows a long black day. It gaps opposite the trend and is completely engulfed by the real body of the first day.

Harami Cross

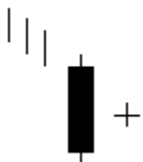

This is a two day pattern. A long black day is followed by a doji. It gaps opposite the trend and is completely engulfed by the real body of the first day.

Homing Pigeon



This is a two day pattern. The first day is a long black day. The second day is a smaller black day that is within the body of the first day. In a downtrend, the bears continue to have their way. However, the second day opening and closing within the body of the first day suggests an erosion of the downtrend. Ensuing sell-offs, followed by buy-ins could result in a reversal.

Inverted Hammer



This is a one day pattern. The lower end of the trading range is characterized by a small real body. The upper shadow is usually not more than twice as long as the real body. The lower shadow is not formed or is very negligibly present.

Kicking

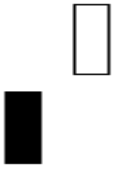

This is a two day pattern. A Black Marubuzo (open is the high of the day and the close is the low of the day) day is followed by a White Marubuzo (open is the low of the day and the close is the high of the day) day that gaps in the opposite direction.

Ladder Bottom

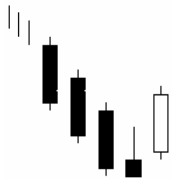

This is a five day pattern. Three almost identical black days occur with successive lower opens and lower closes. Then the fourth day is a black day, which has some noticeably upper shadow. The final day is a white day that gaps against the trend. It opens above the body of the fourth day.

Mat Hold

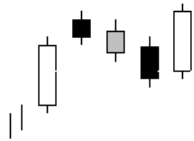

This is a five day pattern. A long white day in an uptrend is followed by a comparatively small black day that gaps in the direction of the trend. The next two days that follow are small days that stay within the range of the first day. The fifth day is a long white day that closes above the close of the first day and continues the uptrend.

Matching Low

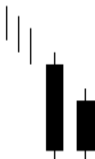

This is a two day pattern. A long black day is followed by another black day. Both the candles have the same close. In a downtrend, two black days occur with an equal close. This suggests short-term support, and can cause a reversal on the next day of trading.

Meeting Lines

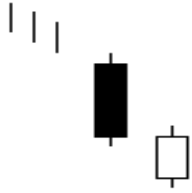

This is a two day pattern. A long black day is followed by a long white day that gaps in the direction of the trend. The second candle closes at the same price as the black day's close. Even though the second day opens low, it rallies to close at the close of the previous day. This typically means a reversal is likely.

Morning Doji Star

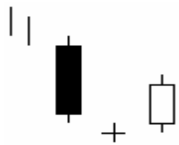

This is a three day pattern. A black day is followed by a doji that gaps in the direction of the trend. The third day is a white candle that closes in the top half of the black day.

Morning Star

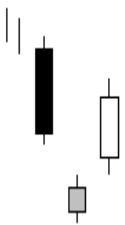

This is a three day pattern. A long black day is followed by a relatively very small day that gaps in the direction of the trend. The third day, a white day, ends with a close in the top half of the black day.

Piercing Line



This is a two day pattern. A white day follows a long black day that gaps below the black day's low and closes within and above the midpoint of the black day's body.

Rising Three Methods

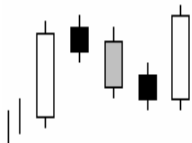

This is a five day pattern. A long white day creates an uptrend. It is followed by three relatively small candles that move opposite the trend but stay within the range of the first day. The last day is a long white day that closes above the close of the first day and continues with the uptrend.

Separating Lines

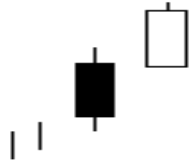

This is a two day pattern. A black day is followed by a white day. Both days have the same opening price.

Side by Side White Lines

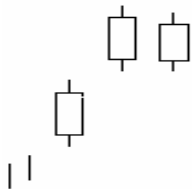

This is a three day pattern. All the candles in this pattern are white candles. A white day is followed by another white day that gaps in the direction of the trend. The third candle is almost identical to the second day.

Stick Sandwich

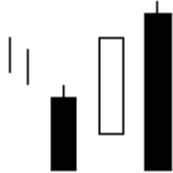

This is a three day pattern. Two black days have a white day sandwiched between them. The white day gaps against the downtrend and closes above the black day's high. The third day's close is the same as the first day.

Three Inside Up

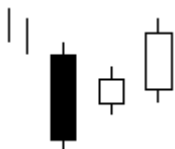

This is a three day pattern. A bullish Harami pattern is depicted at first. It is followed by a white day that closes higher than the second day.

Three Line Strike

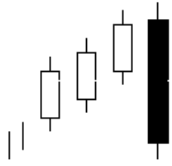

This is a four day pattern. Three long white days have consecutive higher closes. This is followed by a black day. It gaps open in the direction of the trend and closes below the open of the first day.

Three Outside Up

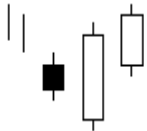

This is a three day pattern. A bullish engulfing pattern is followed by a white day that closes higher than the second day.

Three Stars in the South



This is a three day pattern. First there is a long black day with a long lower shadow. This is followed by a similar but smaller black day with a lower shadow shorter than on the first day. The third day is a small Black Marubozu (open is the high of the day and the close is the low of the day) and it lies within the second day's trading range.

Three White Soldiers

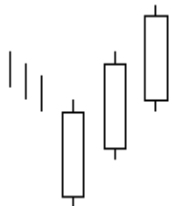

This is a three day pattern of white sticks. Three long white days occur with each successive open being within the body of the previous day and each successive close being higher than the previous day and near the day's high.

Tri Star

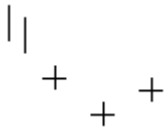

This is a three day pattern. Doji are observed on three consecutive trading days with the second gapping down and the third gapping up.

Unique Three River Bottom



This is a three day pattern. The first day is a long black day followed by a Homing Pigeon whose lower shadow is too long and creates a new low. The last day is a white small day, and closes below the second day's close.

Upside Gap Three Methods

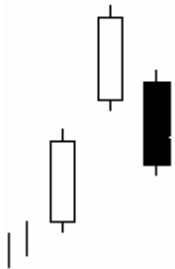

This is a three day pattern. A long white day is followed by a second long white day that gaps in the direction of the trend. The third day is black and fills the gap between the first two days.

Upside Tasuki Gap

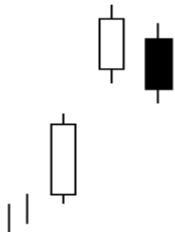

This is a three day pattern. A long white day is followed by a second relatively small white day that gaps in the direction of the trend. The third day is a black day and opens within the body of the second day and closes within the gap.

Bearish Patterns

A bearish pattern is evident when prices open near the high and close significantly lower near the period's low. Thirty- four bearish candlestick patterns are described below.

Abandoned Baby



This is a three day pattern. The first day is a long white day. The next is a doji that gaps in the direction of the trend. The third is a black day gapping in the opposite direction with no coinciding shadows.

Advanced Block



This is a three white day pattern. Each day opens within the body of the previous day and closes above the previous day. The bodies of the candles grow smaller on each successive day. The upper shadows follow a reverse pattern. Each candle is bigger than the previous one.

Belt Hold

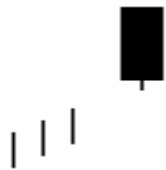

This is a one day pattern. It is a black day with no upper shadow and a close near the day's low.

Breakaway

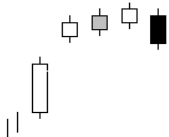

This is a four day pattern. A long white day is followed by a smaller white day that gaps above the first day. The next two days are also smaller and comparable to second day. They move in the same direction with higher consecutive closes. The final day is a long black day that closes in the gap between the first and second days.

Dark Cloud Cover



This is a two day pattern. A black day follows a long white day. The black day gaps above the high of the white candle and then closes below the midpoint of the white day's body.

Deliberation

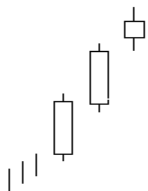

This is a three white day pattern. A long day is followed by a second similar long day, which closes higher than the first. The third white day displays a white spinning top or doji. It gaps above the second day.

Doji Star



This two day pattern consists a long white day followed by a doji that gaps in the direction of the trend. The doji does not have a long shadow.

Downside Gap Three Methods

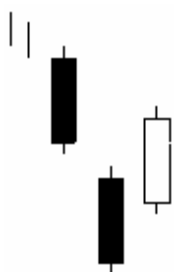

This is a three day pattern. Two long black days occur in succession. The second black day gaps in the direction of the trend. The third day is a white day and it fills the gap between the first two days.

Downside Tasuki Gap

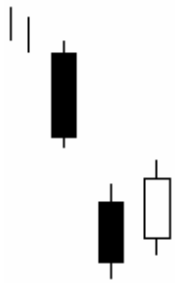

This is a three day pattern. A long black day is followed by a second black day shorter than the first. It gaps in the direction of the trend. The third day is white, opens within the body of the second day and closes within the gap.

Dragonfly Doji



This is a one day pattern. A doji forms at the upper end of a trading range with a long lower shadow which has no or a very small upper shadow.

Bearish Engulfing



This two day pattern occurs when a white day is completely “engulfed” by a large black day that gaps above the white day’s high and closes below its low.

Evening Doji Star

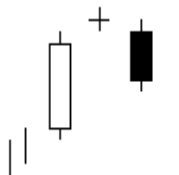

This is a three day pattern. A doji that gaps in the direction of the trend follows a long white day. The third day is a black day that closes in the bottom half of the white candle.

Evening Star

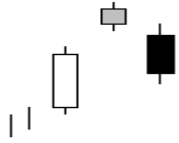

This is a three day pattern. A small body that gaps in the direction of the trend follows a long white day. The third day is a black day that closes in the bottom half of the white candle.

Falling Three Methods

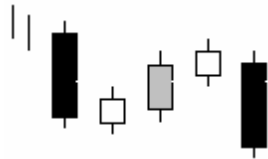

This is a five day pattern. Three small candles that move opposite the trend but remain in the range of the first day follow a long black day in a downtrend. The fifth day is a long black day that closes below the close of the first day and continues with the downtrend.

Gravestone Doji



This is a two day pattern. A white day is followed by a doji. The doji forms at the lower end of the trading range. The upper shadow is usually long while the lower shadow is small or almost nonexistent.

Hanging Man



This is a one day pattern. A small real body forms at the upper end of the trading range with a long lower shadow but with no or almost no upper shadow.

Harami

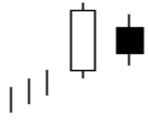

This is a two day pattern. A small black day follows a long white day. The black day gaps down and is completely engulfed by the real body of the white day.

Harami Cross



This is a two day pattern. A doji that gaps down and is completely engulfed by the real body of the first day follows a long white day.

Identical Three Crows



This is a three day pattern. Three identical black days occur with the open of each day being the same as the close of the previous day.

In Neck

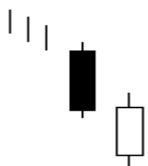

This is a two day pattern. A long white day follows a similar black day that gaps down at the open and closes at the same price as the black day.

Kicking

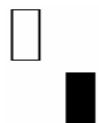

This is a two day pattern. A White Marubuzo (opens at low and closes at high) is followed by a Black Marubuzo (opens at high and closes at low) that gaps down.

Meeting Lines



This is a two day pattern. A long white day is followed by a comparatively smaller black day that gaps up at the open. It then drops to close at the same price as the earlier day's close.

On Neck

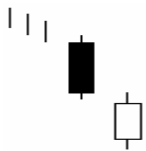

This is a two day pattern. A long black day is followed by a long white day that gaps down at the open and closes below the close of the black day.

Separating Lines

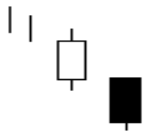

This is a two day pattern. A white day is followed by a black day. Both days have the same opening price.

Shooting Star



This is a one day pattern where a small body forms after the white body at the lower end of the trading range. The upper shadow is usually long while the lower shadow is small or almost nonexistent.

Side By Side White Lines

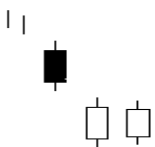

This is a three day pattern. A black day is followed by two white days similar to each other. The first white body gaps in the direction of the trend.

Three Black Crows



This pattern consists in three long black days. These days occur with each successive open being within the body of the previous day and each successive close being below the previous day's.

Three Inside Down



This is a three day pattern. A bearish Harami pattern is trailed by a black day that closes lower than the second day.

Three Line Strike



This is a four day pattern. Three black days with consecutively lower closes are followed by a fourth long white day that gaps in the direction of the trend and closes above the open of the first day.

Three Outside Down

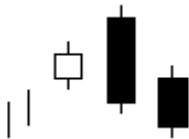

This is a three day pattern. A bearish Engulfing pattern is trailed by a black day that closes lower than on the second day.

Thrusting

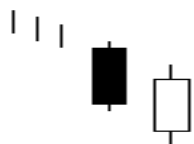

This is a two day pattern. A white day follows a black day that gaps in the direction of the trend and closes below the midpoint of the black day.

Tri Star

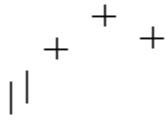

This is a three day pattern. A doji occurs on three consecutive trading days with the second gapping up and the third gapping down (in the opposite direction).

Two Crows

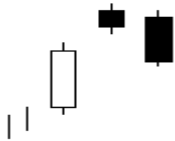

This is a three day pattern. A long white day is followed by a black candle that gaps up in the direction of the trend. The final day is a black day that opens within the body of the small black day and drops to fill the gap closing within the body of the first day.

Upside Gap Two Crows

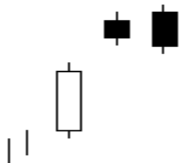

This is a three day pattern. Two black candles follow a long white day with the first black candle gapping in the direction of the trend. The second black day engulfs the small black day and closes within the gap of the first two days

Pattern analysis can help make short-term or long-term forecasts. The patterns put all buying and selling into perspective by consolidating the forces of supply and demand into a concise picture. They present a complete pictorial record of all trading, depicting the battle raging between bulls and bears. They can help determine who is winning the battle so that traders and investors can position themselves accordingly.

Reliability of Pattern Recognition

Candlestick pattern recognition is a reliable method of trend analysis otherwise it wouldn't have been in existence for more than 400 years. A system that has been preserved for so long must be credible enough. The history of the system and the stories of successful rice traders say a lot about the reliability of the system.

The candlestick pattern system is able to identify where the buying or selling is occurring. The system eliminates emotion and enhances existing technical methods. Using this technique one knows when to get into and out of a trade. But like any other analysis and market prediction technique, candlesticks perform better under certain circumstances than in others. They are able to predict trends in some markets and commodities better than in others.

The reliability of candlestick patterns also depends upon various factors which keep changing from market to market and from user to user. The ability of the chart reader plays a major role in the analysis. The chart reader needs to identify each candle accurately to analyze the trend accurately. The chart reader also needs to observe the relationship the candle period has to the period and trend that precede it and the present position of the candle. The number of candles that a pattern follows in the wave measured from the peak or valley that started that wave also needs to be observed. The type of security that one is observing or the nature of the particular stock also has an impact on the reliability of the chart.

Candlestick patterns are known to be very reliable indicators of trend reversals. However there are many activities and corrections that are always taking place in the market, and these can sometimes prevent trend reversals from taking place. This does not however indicate that candlesticks are not reliable, because in the absence of these corrections and other external influences, the reversal would have very likely taken place. In short, candles are very reliable.

However, in candlestick chart analysis some indicators are definitely more reliable than others in determining the short-term future of an investment. The indicators that take three or more days to develop or those that have strong candlesticks, such as stars or Marubuzos are more reliable than others. The following table shows the different patterns with their respective reliabilities.

BULLISH TRENDS		
Candlestick Patterns	Pattern	Reliability
Abandon Baby	Reversal	High
Belt Hold	Reversal	Low
Breakaway	Reversal	Moderate
Concealing Baby Swallow	Reversal	High
Doji Star	Reversal	Moderate
Dragonfly Doji	Reversal	Low/moderate
Engulfing	Reversal	Moderate
Gravestone Doji	Reversal	Low/moderate
Hammer	Reversal	Low/moderate
Harami	Reversal	High
Harami Cross	Reversal	High
Homing Pigeon	Reversal	Moderate
Inverted Hammer	Reversal	Low/moderate
Kicking	Reversal	High
Ladder Bottom	Reversal	Moderate
Mat Hold	Reversal	High
Matching Low	Reversal	High
Meeting Lines	Reversal	Moderate
Morning Doji Star	Reversal	High
Morning Star	Reversal	High
Piercing Line	Reversal	Moderate
Rising Three Methods	Reversal	High
Separating Lines	Reversal	Low
Side by Side White Lines	Reversal	High
Stick Sandwich	Reversal	Moderate
Three Inside Up	Reversal	High
Three Line Strike	Continuation	Low
Three Outside Up	Reversal	High
Three Stars in the South	Reversal	Moderate

Three White Soldiers	Reversal	High
Tri Star	Reversal	Moderate
Unique Three River Bottom	Reversal	Moderate
Upside Gap Three Methods	Reversal	Moderate
Upside Tasuki Gap	Continuation	Moderate

BEARISH TRENDS		
Candlestick Patterns	Pattern	Reliability
Abandon Baby	Reversal	High
Advanced Block	Reversal	Moderate
Belt Hold	Reversal	Low
Breakaway	Reversal	Moderate
Dark Cloud Cover	Reversal	High
Deliberation	Reversal	Moderate
Doji Star	Reversal	Moderate
Dragonfly Doji	Reversal	Low/moderate
Downside Gap Three Methods	Continuation	Moderate
Downside Tasuki Gap	Continuation	Moderate
Engulfing	Reversal	Moderate
Evening Doji Star	Reversal	High
Evening Star	Reversal	High
Falling Three Methods	Continuation	High
Gravestone Doji	Reversal	Low/moderate
Hanging Man	Reversal	Low/moderate
Harami	Reversal	Low
Harami Cross	Reversal	Moderate
Identical Three Crows	Reversal	High
In Neck	Continuation	Moderate
Kicking	Reversal	High
Meeting Lines	Reversal	Moderate
On Neck	Continuation	Moderate
Separating Lines	Continuation	Low
Shooting Star	Reversal	Low/moderate
Side By Side White Lines	Continuation	Moderate
Three Black Crows	Reversal	High
Three Inside Down	Reversal	High

Three Line Strike	Continuation	Low
Three Outside Down	Reversal	High
Thrusting	Continuation	Low
Tri Star	Reversal	Moderate
Two Crows	Reversal	Moderate
Upside Gap Two Crows	Reversal	High

To make the entire process of analysis more reliable, candlestick charts should be used in combination with other technical analysis techniques. If there is a reversal signal from the system being used, then one should check the candlestick chart for a confirmation of this trend.

It is not easy to check an analysis system such as candlestick charts for reliability. Hence candlestick analysis should be used as an additional, tool not as a system. Candlestick charts can identify reversals unerringly and that in itself is reason enough to use them. They give early turning signals not available with any other technique. But one should not rely solely on candlestick charts for investing in the market. Any identified trend should always be confirmed by another technique. Only if both techniques indicate the same trend should one come to a conclusion. This sometimes takes time to master, but overall candle patterns are very easy to learn and adapt to other trading techniques.

Using Candlestick Patterns in Stock Analysis

The popularity of Japanese candlestick trading in the U.S. investment community has been rapidly rising over the past decade. Whereas just a few short years ago, relatively few traders were using candlesticks – nowadays, virtually every stock charting platform includes a candlestick charting option. It is common knowledge that the stock market is not a place for the uninformed, and it is likely that a successful professional stock market investor has many years of experience in the market. This knowledge creates a huge advantage for the successful trader, and many rely extensively on Japanese candlestick trading.

Stocks That Work Best With Candlesticks

One of the great things about candle charts is that they work exceptionally well in any market—especially today's dangerous and volatile environment. Candle-charting techniques help improve your trading profits and also help you avoid bad trades.

Candlesticks work well for stocks that are high, medium or low priced. They also work well for stocks having high, medium, or low average volume. Often candlesticks are used for low capitalization stocks. Low-cap stocks are often not considered by portfolio and fund managers with huge sums to invest. This is an area where the small investor can have an advantage using a charting system plus candlesticks, and can reap in large profits.

Candlesticks work especially well with NASDAQ stocks. If one follows the NASDAQ closely, the evening star patterns are especially reliable.

The Japanese believe stocks' personalities are like people's faces — no two are same. Although candlesticks can be used in for all stocks, some patterns will work well in certain markets and others will not work as well. Experience helps in determining which ones will be helpful in which situations.

Candles Light the Way: Corporate Illustrations

The visual aspects of candlestick investing are so simple to understand that the concepts of candlestick analysis become quickly familiar to users. The candlestick signals at the bottoms and the tops of the stock prices simplify reviewing the historic price variations.

Candlestick analysis reduces stock market investing to one simple basic principle, what stocks are going up and what stocks are going down. This cuts to the heart of investing philosophy, buy stocks that are going up, sell stocks that are going down. The clear visual depiction of candlestick stock market charting completely alters investment decision making

Daily Chart WAL –MART Stores (WMT)

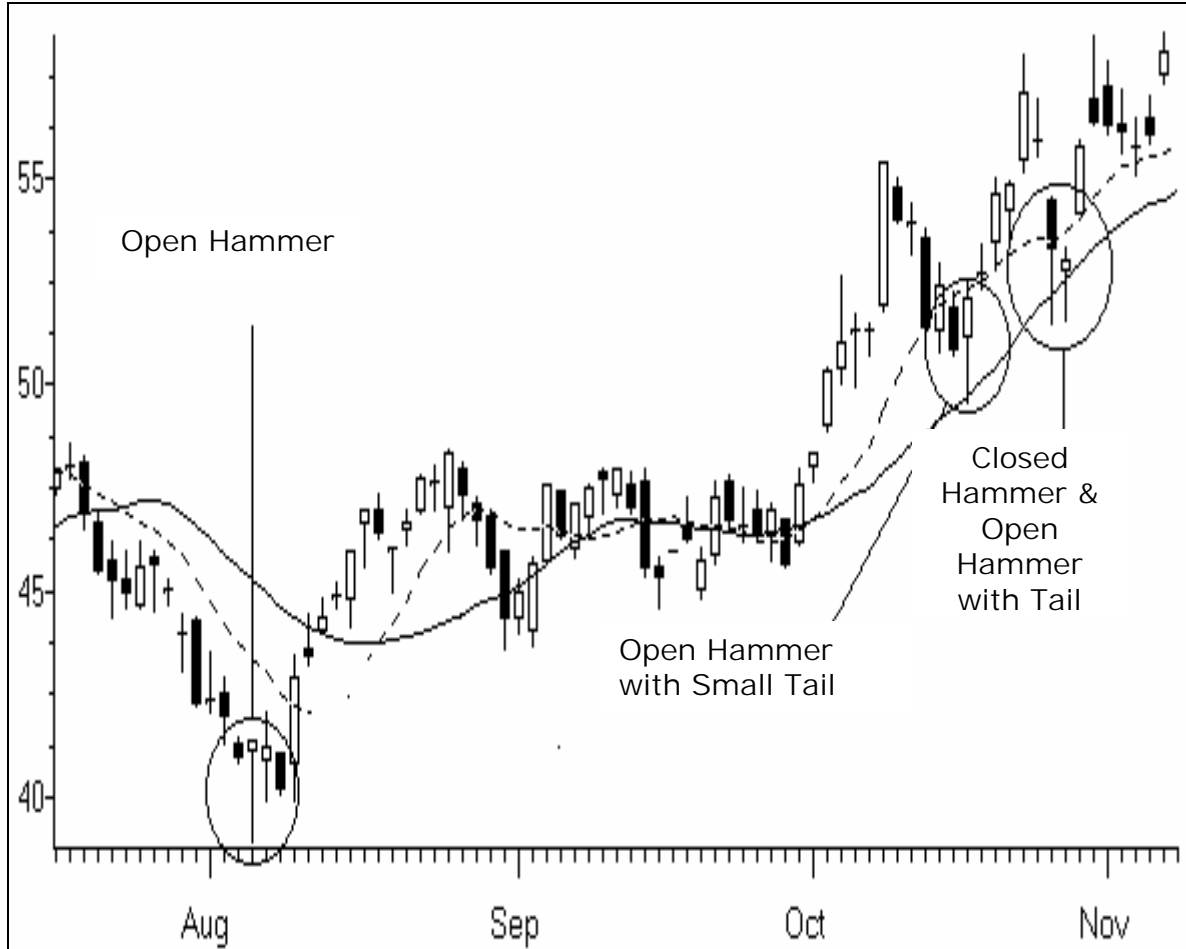

This chart of Wal-Mart shows what hammers look like using real examples. Each hammer circled in the chart occurred after several days of a downtrend in the stock. Each was also at support, either moving average or strong price support.

The first hammer circled is the most perfect one. The body is very small compared to the tail and the fact that it is an open candlestick adds more strength to it as a reversal indicator. The next two sets of candlesticks are ones more likely to prompt someone to enter the stock. This stock has a breakout from the sideways trend on the daily to new highs and a pullback to support in what becomes a new up trend.

Both offer perfect scenarios to buy above the high of the hammers. For example in this particular scenario - in a stock of the \$50 range, let the high of the hammer break by 3/16

before entering long. Place your stop at just below the low of the hammer. You could also place your stop below the low of the day when the stock sets up (i.e. the day following the shooting star) but the first stop mentioned is preferred. However, in both cases above, there is a gap with the gap off the last hammer being the most severe. A sensible investor will make sure to use the 30-minute gap rule in these instances.

This means that the 30-minute high should be marked and when that is broken, the investor would normally go long. The more support one has on a chart in addition to the hammer candlestick, the stronger is the setup.

Daily Chart Cintas Corp (CTAS)

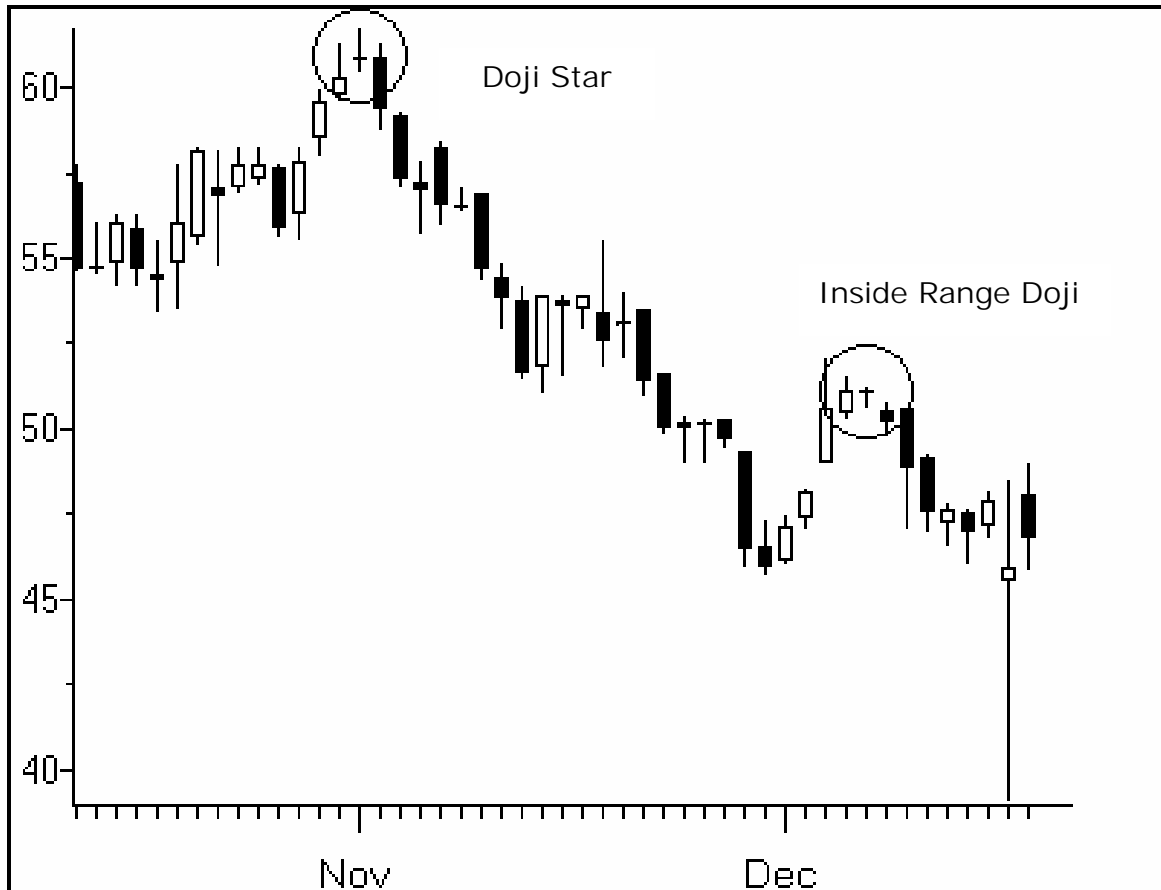

In this second example, a reversal pattern is visible, a downtrend in which dojis come into play. The first doji is involved in a setup known as a doji star. This occurs when a doji gaps above the body of the previous candlestick. This setup is visible in rising markets, as CTAS was until this point starting back in August. This setup serves as a warning that the trend is liable to change and you can see confirmation of this change in trend on the following day.

The second doji in this example is also part of a larger pattern or setup known as a triangle. In this case we see a series of two inside range days following a larger candlestick.

This pattern, combined with the downtrend, shows that the trend is likely to change once again and continue to move downwards. A smart investor will look to go short the day following the

inside range day doji, just under it's low in this case. The stop would be just above the high of the doji, although one can also use just above the high of the triangle as well.

Without proper guidance most investors learn to invest through years of undirected hard knocks. Many years of research, examination, identification and plain common sense analysis are already built into the candlestick signals. Whether you are a beginner or a seasoned trader, Japanese candlesticks can alter and improve your investment psychology, and lead to better returns.

Interpreting Candlestick Patterns

Interpreting candlestick patterns after identifying them is the key to proper decision-making. A person makes a decision on the basis of the interpretation drawn from the pattern. One should always confirm a candlestick pattern before making a decision. Most of the patterns can be confirmed and hence one should wait for confirmation to eliminate decisions based on premature or incorrect candlestick signals.

The section below groups candlestick patterns into the following categories: bullish, bearish, tweezers and extended. It also interprets each candlestick pattern and provides examples of decisions to be made in each case.

Bullish Patterns

Engulfing Bullish



This is a common bullish pattern and is interpreted as a buy signal. An engulfing bullish pattern after a defined down trend normally signals a bullish reversal. It is normally wise to wait for confirmation. This pattern is a reversal signal only if it follows a downtrend. It should be ignored if it does not occur after a downtrend. The shorter the real body of the black candle and the longer the real body of the white candle the more powerful the signal. It is usually an important reversal signal.

Piercing Line



This may indicate the end of a bearish trend. With confirmation, this pattern indicates a bullish or buy signal. This pattern is a reversal signal only if it follows a downtrend. It should be ignored if it does not occur after a downtrend. The white candle opens below the low of the prior black day. However, the prices push higher and the candle closes above the midpoint of the prior day's black real body. The greater the degree of penetration into the black real body, the more likely it will be a bottom reversal.

Bullish Harami Line



This is interpreted as indicating a potential market reversal. The harami line is a sign of market consolidation. With confirmation, this pattern indicates a bullish or buy signal. This pattern is a reversal signal only if it follows a downtrend. It should be ignored if it does not occur after a downtrend. The Harami is not usually a significant reversal pattern.

Abandoned Baby Bottom

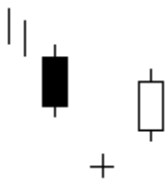

An abandoned baby bottom is a major bottom reversal signal and is extremely rare. It is a reversal signal only if it follows a downtrend and it should be ignored if it does not occur after a downtrend. It is a distinctive form of the morning doji star and the doji star must have a gap before and after it (the shadows do not touch).

The Bullish Harami Cross



This is a distinctive form of the bullish Harami. The second candlestick is a doji, which gives it more importance. It is usually a major reversal signal, but only if it follows a downtrend and should be ignored if does not occur after a downtrend.

Morning Star

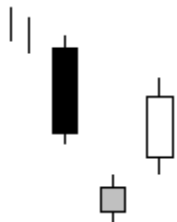

A morning star is a long black real body followed by a small real body that gaps lower (a star). The third candlestick is a long white candlestick that moves well within the first period's black real body. It is usually an important reversal signal, but only if it follows a downtrend. It should be ignored if does not occur after a downtrend.

Inverted Hammer with Confirmation



This indicates the potential for a bottom reversal if found after a downtrend. This is a very common bottom reversal indicator - buy with confirmation. It is important to wait for bullish confirmation on the session following the inverted hammer. Confirmation could be in the form of the next day opening above the inverted hammer's real body. A white candlestick with higher prices can also be another form of confirmation

Hammer with Confirmation



This is the inverse of the Inverted Hammer. This is a candlestick with a long lower shadow and a small real body. The lower shadow is at least twice the length of the real body. The real body is near the trading point; the upper shadow would be short. A hammer emerges after a downtrend, signalling that the downtrend should end.

Bearish Patterns

Abandoned Baby Top



An abandoned baby top is a major top reversal signal and is extremely rare. It is a distinctive form of the evening doji star. The doji star must have a gap before and after it (the shadows do not touch). It is a reversal signal only if it follows an up trend and should be ignored if does not occur after an up trend.

Engulfing Bearish



This is a common bearish or sell pattern. An engulfing bearish pattern after a defined up trend normally signals a bearish reversal. It is normally wise to wait for confirmation. The shorter the real body of the white candle and the longer the real body of the black candle the more powerful the signal. It is usually an important reversal signal.

Evening Star

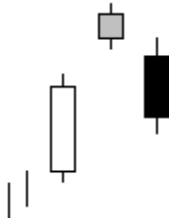

This is a long white real body followed by a small real body that gaps higher (a star). The third candlestick is a long black candlestick that moves well within the first period's white real body. It is usually a major reversal signal, but only if it follows an up trend. It should be ignored if does not occur after an up-trend.

Dark Cloud Cover



This may indicate the end or correction of a bullish trend. With confirmation this pattern indicates a bearish or sell signal, but it is normally wise to wait for confirmation. This pattern is a reversal signal only if it follows an up trend, but should be ignored if does not occur after an up trend. A Bearish Engulfing Line is a more meaningful top reversal.

Bearish Harami Line



This indicates a potential market reversal. The harami line is a sign of market consolidation. With confirmation, this pattern indicates a bearish or sell signal. This pattern is a reversal signal only if it follows an up trend and should be ignored if does not occur after an up trend. The Harami is not usually a significant reversal pattern.

Bearish Harami Cross



This pattern is a reversal signal only if it follows an up trend. It should be ignored if does not occur after an up trend. This is a distinctive form of the bearish Harami. The second candlestick is a doji, which gives it more importance. It is usually a major reversal signal.

Shooting Star or Inverted Hammer



This indicates the potential of a top reversal if found after an up trend. This is a very common top reversal, or consolidation indicator. This is interpreted as a sell signal but one should sell with confirmation. This pattern is a reversal signal only if it follows an up trend and should be ignored if does not occur after an up trend. The shooting star has a small real body with a long upper shadow and a short lower shadow. Its real body should gap above the previous candle's real body. It is usually not a major reversal signal.

Hangman with Confirmation



This is the inverse of the Inverted Hammer. This is a candlestick with a long lower shadow and a small real body. The lower shadow is at least twice the length of the real body. The real body is near the trading; the upper shadow would be short. A hammer emerges after a downtrend, signalling that the downtrend should end. A Hanging Man emerges after a rally, signalling the prior move may be ending. They are usually important reversal signals.

Doji

A doji indicates tightening of price activity. As price activity tightens, the potential for a reversal or breakout becomes more probable. When dojis form in groups, more pressure is created thus we have a high probability of a major reversal or breakout. When the price trend establishes direction, the pressure is released. Single, high volume dojis that gap above or below previous price levels are strong indications of a potential major top or bottom.

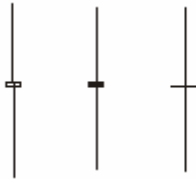

A doji is an indication of extreme market consolidation and shows signs of a potential reversal. One with high volume shows the intense pressure of the trading session. Large volume dojis after a large price move are strong indicators of major tops and bottoms. In a defined, longer-term trend it is not uncommon to see four or five dojis in a group that form near correction points. Doji sessions are only important in markets where there are not many doji. A doji represents indecision. Doji are able to call market tops, especially after a long white candlestick in an up trend. Uncertainty by buyers does not maintain an up trend. One should wait for confirmation during a downtrend. The market can still fall lower.

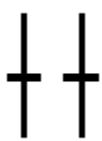

Double Doji: A double doji is two adjacent doji lines. It implies that a forceful move follows a breakout from the current indecision. Double doji indicates tightening pressure with no price movement.

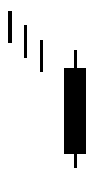

Doji Star: This is a star with a doji. It is more powerful than a star because it contains a doji. A star indicates a reversal and a doji indicates indecision. Thus, this pattern usually indicates a reversal following an indecisive period. You should wait for confirmation before trading a doji star.



Evening Doji Star: This pattern is a reversal signal only if it follows an up trend. It should be ignored if it does not occur after an up trend. An evening doji

star is a distinctive form of evening star. The star is a doji and is therefore more important than the evening star.



Gravestone-Doji: This pattern is a distinctive form of the Dragonfly-Doji with a long upper shadow and no lower shadow. It is a serious warning signal if it follows an up trend. The reliability of this signal depends on the length of the upper shadow. The longer it is the more probable is the upcoming downtrend.



Morning Doji Star: This pattern is a reversal signal only if it follows a downtrend and should be ignored if does not occur after a downtrend. A morning doji star is a distinctive form of morning star. The star is a doji and is therefore more important than the morning star.



Dragonfly Doji: This candle is a reversal signal only if it follows a downtrend. It is defined by a long lower shadow, and the lack of an upper shadow combined with the equality of closing and open. The longer the lower shadow the more bullish the signal.

Tweezers Patterns

Tweezers patterns show levels of support and resistance.

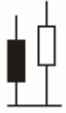

Tweezers bottoms indicate a support level at or below the lows of the pattern. If the support level is broken with a large black candle or includes a price gap, proper action is to sell. This pattern is a reversal signal only if it follows a downtrend. It should be ignored if it does not occur after a downtrend. Tweezers are not usually a vital reversal signal.



Tweezers tops indicate a resistance level at or above the highs of the pattern. This pattern is a reversal signal only if it follows an up trend. It should be ignored if it does not occur after an up trend. The length and colour of the second candle does not matter.

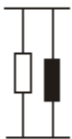

Tweezers tops and bottoms indicate a very tight support and resistance level near the highs and lows of the pattern with a strong potential for an accelerated price move.

Extended pattern groups

When a stock is completing a move, it experiences a period of deceleration referred to by chartists as price consolidation. Consolidation is one of the most important signals that a stock is about to begin a new move. The move can be a continuation in the same direction, or it can be a reversal in the opposite direction. The area of consolidation represents a battle zone where the bears are at war with the bulls. The outcome of the battle often defines the direction of the next move. The extended pattern groups can only give the outcome. There are four types of extended pattern groups.

Confirmation

Confirmation patterns are created after an initial candlestick pattern has formed. The confirmation pattern is considered a conservative traders entry point. They identify that the initial candlestick pattern now has a higher likelihood of prompting a market price move in the directing predicted. Confirmation patterns are an essential part of trading with candlesticks and have been taught to generation after generation of Japanese.

Continuation

Continuation patterns are created after an initial candlestick pattern has formed, and normally appears after a confirmation pattern. The continuation patterns are used to identify a trending market and to maintain an awareness of the trend strength. Many times, continuation patterns will form during the individual Three Level Fluctuations as described earlier. These continuation patterns are generally helpful to keep you long or short during a defined market trend after the initial candlestick buy or sell pattern.

Combination

Combination patterns are fairly simple to understand. They are created when two or more individual candlesticks, or two or more individual multi candlestick patterns, or any combination thereof, appear side by side and issue similar signals. An example would be a "Hanging man and Doji Line" found at or near a ceiling. This is a strong indication of a potential bearish price move. Combinations patterns are not rare; they appear in generally all stocks and commodities. The key to these unique patterns is to be able to identify them as a stronger influence to a possible future price move and to help identify the direction of the future move.

Confluence

Confluence patterns are composed of a number of other technical oscillators or patterns that assist in confirming or denying the potential for any candlestick pattern probability of success.

For example, one might choose to use Moving Averages, Stochastic, Momentum and Elliot Wave Theory as confluence indicators to assist in determining the current conditions of any market and to assist in confirming the possibilities of the current candlestick pattern. Generally all Western technical oscillators can be used as Confluence patterns. The key is to understand the relationships between the price movement of the chart, the relative change in the Western technical oscillators, and the candlestick pattern that have formed.

The identification of these extended groups is an important factor in decision-making. Without taking these extended groups into consideration one cannot give a proper interpretation of the patterns.

Techniques: Simple Steps for Better Returns

The secret of successful trading is to take a step back from the market. One should trade with the big picture in mind at all times and ignore the day-to-day market movement. Daily market talk can spellbind an investor if it is followed too closely. The focus is on the forest and not the individual trees. Focus should be on the big picture. The stock market is the focal point and not individual stocks. The market has more influence on stock prices than any other factor.

Some steps for success are:

- Search for stocks reaching new heights; or
- Rank the stocks using relative performance over the last one year.
- Select the top 10 per cent of these stocks for further study

The key is to buy when the market signals the start of a bull trend and selecting the leading stocks that are outperforming the market. The next step is to sell when the bull trend has ended.

Candlestick analysis reduces stock market investing to one simple principle -- that of gauging which stocks are going up and which stocks are going down. This is the investing philosophy; buy stocks that are going up, sell stocks that are going down. The clear visual depiction of stock market charting tends to improve investment abilities.

There are two iron rules that regulate stock market using the candlestick charting:

1. Demand and price are directly proportional to each other.
As demand goes up, prices go up.
2. Supply and price are indirectly proportional to each other.
As supply increases, prices go down.

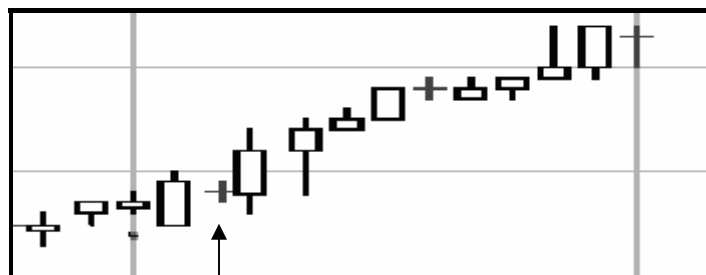

Looking at the chart depicted above, the break between white candlesticks shows that demand has increased substantially. There is a great possibility that price will also go up.

A big white candle shows that the price is going up strongly. Demand is greater than supply which means that an investor will strongly buy this stock since the common perception is that the price will go up further. A remissive white candle shows that resolution is weakening. Buyers doubt that this stock will go up or down. A big black candle shows that market's players are strongly dumping this stock. A remissive black candle shows that sellers are stopping and doubting that the stocks' course may change.

In a nutshell, small candles show the market's indecision. If this indecision occurs at the trend's top, sell your stock. And if this indecision occurs at the trend's bottom, buy the stock.

It is best for an investor to wait and watch when any of these trends occur

1. Trend is falling.
2. Trend is in an indecisive state.
3. Trend is at bottom.

Successful trading is much more difficult than it appears. Experience in the stock markets is a long process of watching the market and practicing chart pattern recognition. With time, one can learn to avoid low-potential situations. Planning trade breakouts should be done daily using the previous day's high and low to set trade alerts. Using this method to trade with the trend on breakouts will help traders avoid overtrading and selectively trade the strongest and most powerful chart patterns.

When it comes to trading using candlesticks, one must learn to develop the acumen needed to read the charts accurately and reap the ensuing benefits. These small tips revealed here will lead to greater trading opportunities and safer trading.

What Candlesticks don't reveal

Candlesticks charting technique has become very popular among traders in recent years. This is partially because one important advantage comes from the combining of patterns. These often reveal changes in volatility and momentum without the use of oscillators and other derivatives of price. By using oscillators in addition to candlesticks this analysis becomes very powerful. The disadvantage is that the charts reflect short-term outlooks sometimes lasting less than eight to ten trading sessions. Candlestick charting is a very complex and sometimes difficult system to understand. Candlestick Charting is not the only pattern technical analysis system but it is one of the few better-known ones. Like most facets of technical analysis, candlesticks aren't perfect but can be used to point the way in conjunction with other tools.

A big difference between bar charts and Japanese candlestick lines is the relationship between opening and closing prices. Bar charts place more emphasis on the progression of today's closing price from yesterday's close. With candlestick, chartists are more interested in the relationship between the closing price and the opening price on the same trading day.

Candlestick charts are mainly used to confirm the underlying trend, trend-reversals and the balance of supply and demand. Two important points to consider while using candlestick are the timing of the 'reversal bar' and 'confirmation' of the trend. A Reversal bar is generated when three successive bullish (WHITE) or bearish (BLACK) bars are formed and today's price is traded below the lowest of all prior three WHITE bars (in case of bearish reversal) and vice-versa. The disadvantage of candlestick charts is that the signals are generated after the new trend is well under way. That is in the candlestick charts a trend reversal bar could be late, as a substantial move might have already happened.

Most candlestick patterns are reversal patterns i.e., they are supposed to alert traders to an impending change in a market's underlying trend. However, because a basic tenet of technical analysis is that trends are more likely to continue than reverse, reversal patterns can work at a disadvantage. Essentially, reversal patterns tease traders by telling them, "Although a trend is more likely to continue than reverse, this trend is going to reverse now." Of course, candlestick

patterns sometimes do correctly forecast major reversals of the dominant trend, but more often than not, the major trend resumes after undergoing a correction or a period of congestion.

Candlestick patterns are more reliable when they signal the end of countertrend declines in uptrends and the end of countertrend rallies in downtrends. In these cases, the patterns are saying, "The countertrend price swing is ending, and the main trend is resuming."

Candlesticks display the relationship between the open, high, low, and closing prices. They cannot be used to display securities that only have closing prices, nor were they intended to display securities that lack opening prices. If there is a need to do so then these can be displayed by using the previous day's closing prices in place of opening prices on a security that does not have opening prices. This technique can create candlestick lines and patterns that are unusual, but valid.

Although the Japanese candlestick has the disadvantages described above, it is still considered one of the most tested and proven technical trading analysis tools in history; Japanese candlestick trading signals have been successful for over 400 years with Japanese rice traders. There is one dynamically powerful aspect of these reversal signals. They are created by the "change" in investor sentiment.

Concluding Remarks

Hundreds of years ago, Japanese rice traders became extremely wealthy using candlestick charting signals to trade rice. As traders progressed in their use of the charts they were able to analyze the psychology behind the formation of the signals providing a very powerful tool for projecting future price movement.

The most striking feature of Japanese candlesticks is that they are easily understood with a quick glance at a candlestick chart. Among the most compelling candlestick signals are the engulfing patterns. The bullish engulfing pattern is most effective when found in the oversold area at the end of a substantial downtrend. Likewise, the bearish engulfing pattern is most effective when found in the overbought area after a substantial uptrend.

The main advantage candlesticks provide is an insight into the direction of the market. The next consideration is to determine what is happening in other market indexes. Ideally, candlestick signals will identify trades that move straight up after purchase.

Candlestick signals provide an immense advantage to investors when trying to pinpoint the best trades available. The implied logic built into the signals creates a platform that always places the probabilities in the candlestick investor's favor. Being aware that candlestick signals exploit emotions that investors can quickly take advantage of the known weaknesses of the masses and can eliminate that weakness in their own investment decisions so they can profit from having that knowledge.

Candlestick charts capture human emotions in a graphic form. They are produced by the accumulative knowledge of all investors buying and selling a given entity during a particular time frame. Candlestick charts illustrate what is actually going on in investors' minds at the time. By using real-body support and resistance levels, we can try to improve trading and analysis on several levels. In the short term, we can derive important counteraction trading points and improved longer-term entry levels. In the longer term, we can use real-body support and resistance to get a jump on market breakouts in a trend-trading strategy.

Candlestick charting should not be used in a vacuum. This applies to the real-body support and resistance levels as well. Take time to try out this methodology. It will prove to be a beneficial addition to your technical toolbox.

Testing will give you confidence that the patterns work. Testing helps you know at least your worst string of losses so you will be able to pull the trigger when the time comes. You must convince your subconscious mind otherwise your conscious mind may take over and tell you not to buy because the last time you traded this pattern you got burned.

Candlesticks will not revolutionize the basic trading rules, but using them as an important confirmation indicator gives you another way to see and understand price action as it unfolds.

FAQ

What is the origin of candlestick charting technique?

It is still not very clear as to who was responsible for inventing candlestick charts but much of the development has been attributed to Honma. Honma was a wealthy Japanese businessman. He began trading at the local rice exchange in Sakata around 1750.

The most widely accepted theory is that the chart originated at the beginning of the rice market (around 1750) in Japan. The establishment of exchanges in Western Europe (1561) and Japan (1654) provided an ideal environment for the development of the candlestick chart.

What makes a candle?

A candlestick is made up of a thin vertical line with a body that may be empty (white) or green on days when the close was higher than the open, of filled-in black or red when the close is lower than the open.

The body, called the real body, represents the range between opening and closing prices. Vertical lines above and below the real body are called shadows. Shadows indicate high and low prices for that candle.

Why should a trader use candlestick charting instead of western charting methods?

The Candlestick line is a very powerful charting technique. It helps the trader to instantly visualize the fundamental strength or weakness of a stock at a given time.

By observing a green candlestick, for example, the trader immediately knows that the buying pressure is able to overcome selling pressure, resulting in the closing price being higher than the opening price. By seeing a red candlestick, the trader sees that selling pressure is able to overcome buying pressure resulting in the closing price being lower than the opening price.

What are candlestick reversal patterns?

Traders look to bar charts for double tops and bottoms, head-and-shoulders, and technical indicators for reversal signals. A candlestick chart could be used for the same purpose.

A reversal does not always mean that the current uptrend/downtrend will reverse direction, but merely that the current direction may end. The market may then decide to drift sideways.

How effective are the signals?

Signals have a very high probability of producing a profitable trade. Signals, occurring at the proper spots, will produce excellent trades.

Candlestick signals are visual signals and not quantitative numbers. Therefore, it is difficult to develop computer programs to test the effectiveness of each signal.

Recommended Reading

1. Japanese Candlestick Charting by Steve Nison
Prentice Hall Art; 2nd edition (October 30, 2001)
2. Beyond Candlesticks: New Japanese Charting Techniques Revealed (Wiley Finance) by Steve Nison
Wiley; (October 1994)
3. The Candlestick Course by Steve Nison, Marketplace Books
Wiley; 1st edition (May 23, 2003)
4. Profitable Candlestick Trading: Pinpointing Market Opportunities to Maximize Profits by Stephen Bigalow, Stephen W. Bigalow
Wiley; 1st edition (December 21, 2001)
5. Candlestick Charting Explained: Timeless Techniques for Trading Stocks and Futures by Gregory L. Morris
McGraw-Hill Trade; 2nd edition (July 1, 1995)
6. Candlepower: Advanced Candlestick Pattern Recognition and Filtering Techniques for Trading Stocks and Futures by Gregory L. Morris
McGraw-Hill; (September 1, 1992)
7. The Secret of Candlestick Charting by Louise Bedford
Wrightbooks
8. Clarifying The Long-Term Outlook Using Candlestick Charts by Tsutae Kamada
TradingMarkets.com, Inc.

Candlestick Terminology

Black Candlestick - When the close is lower than the open.

White Candlestick - When the close is higher than the open.

Shaven Head - A candlestick with no upper shadow.

Shaven Bottom - A candlestick with no lower shadow.

Doji Lines – They have no real body, but instead have a horizontal line. They are used when the Open and Close are the same or very close.

Real Body - The real body is the 2-dimensional rectangle made by the difference between the open and close of the trading day.

Upper Shadow - This is the vertical line drawn from the top of the candlestick's real body to the day's high.

Lower Shadow - This is the vertical line drawn from the bottom of the candlestick's real body to the day's low.

Long Day - A candlestick has a long day when there has been a big difference in opening and closing price compared to differences seen in the previous five to ten days.

Short Day - A candlestick has a short day when there has been a small difference in opening and closing price compared to differences seen in the previous five to ten days.

Marubozu - A Marubozu candlestick is one that exhibits no (or very little) upper or lower shadow.

Spinning Top - A spinning top is candlestick with a small real body and long upper and lower shadows.

Doji – This is the most extreme case of a spinning top. It occurs when the real body exists as a line.

Star - A star is a small real body that gaps above or below a long candlestick occurring the previous day.

Umbrella - This is similar to a dragonfly doji. An umbrella is a small real body with no upper shadow and a long lower shadow.

Inverted Umbrella – This is similar to a gravestone doji. An inverted umbrella is a small real body with a long upper shadow and no lower shadow.